



SALAMANDERS

SET1



SALAMANDER ELECTRIC

TECHNICAL DATA:

External dimensions - WxDxH (cm)	54x40x39
Heat zones	1
Power (kW)	2

ADDITIONAL TECHNICAL DATA:

Supply (N)	230V 1N 50/60Hz
Weight (kg)	22
Volume (m3)	0.1

Made of stainless steel. Movable upper plate, sliding closer or further to the cooking food. Possibility to heat up only half of the surface. Possibility to hang the appliance on the wall by means of special brackets (to be requested). Incoloy armoured heating elements. Tilting heating elements for easy cleaning under the moving deck. Stainless steel drip trays and chromium-plated steel grids equipped with heat resistant handles, both removable and equipped with a safety stop.

Thermal insulation. Aluminium insulated handle prevents users burning. User friendly display, intuitive and functional.

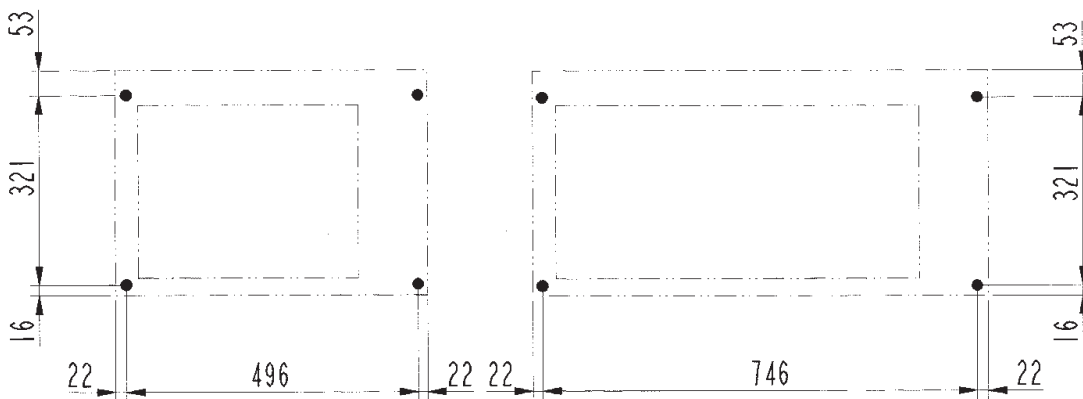
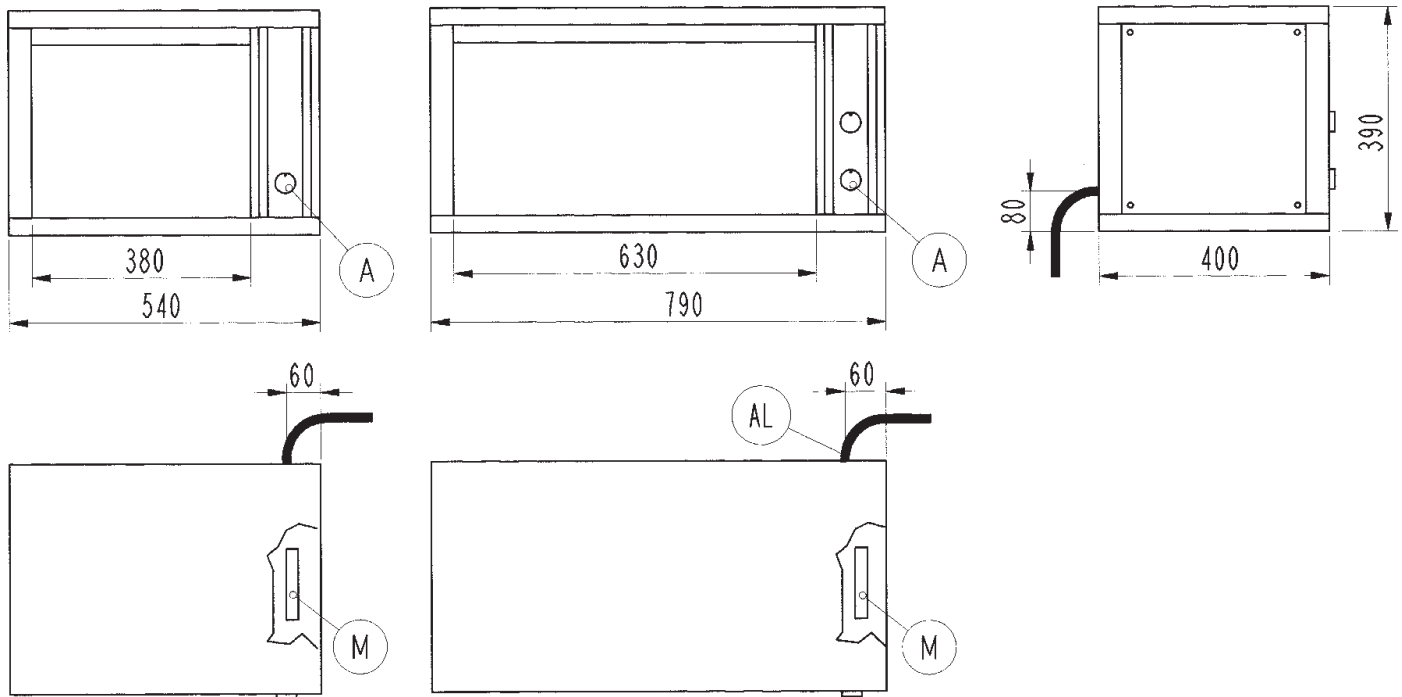

Schema di foratura parete in calcestruzzo per fissaggio staffe
 Schema für Betonwandbohrungen zur Befestigung der Wandhalterungen
 Diagram for drilling cement walls for the fastening of brackets
 Schéma de perçage de la paroi en béton pour fixer les étriers
 Esquema de perforación de la pared de hormigón para fijación soportes