

Client _____ Quantity _____
Project _____ Position _____

Modi Up Blast Chiller

Model: W5U-P

Cod: W11033000011



Technical data

Top:	Thickness 4 cm. Reinforced in order to place an oven
Gross capacity:	134 lt
Temperature range:	-40°+10°C
Ventilation range:	25% - 100%
Humidifier:	Not available
Refrigerant unit:	Plug-in
Yield +90 / +3:	22 Kg
Yield +90 / -18:	17 Kg
Climate class:	5
Cooling gas:	R290
Defrost:	Hot gas
Valve:	Electronic expansion valve
Dimensions (mm):	780×800×853 mm
Packing dimensions:	875×915×901 mm
Gross weight:	125 Kg
Voltage:	220-240 V - 50 Hz
Total rate:	827 W
Absorbed Current:	4,7 A
Cooling capacity:	1349 W*
*:	Evap. -10°C Cond. +40°C

Features

Functions:	Blast chilling, shock freezing, continuous cycle
Standard equipment:	5 slides GN1/1, EN60x40
Control:	4,3" touch screen display with USB port
Doors:	Cushioned, with anti-odor system
Door gasket:	Magnetic, triple chamber and easily replaceable
Core probe:	Needle probe with 1 reading point, quick-release and easily replaceable
Insulation:	60 mm thickness - CFC/HCFC free
Exterior/interior finishing:	Exterior and interior AISI 304 stainless steel.
Inner corners:	Rounded for easy cleaning and ensuring maximum hygiene
Handle:	Stainless steel AISI 304, 2 mm thick
Racks and slides:	Stainless steel AISI 304, quick release
Feets:	AISI 304 stainless steel adjustable h 100/150 mm
Cosmo:	Wi-Fi remote control system

Accessories and variants

- Lowered foot h 55/70 mm
- 4 Swivel and brake castors h 128 mm
- Stainless steel shelf GN1/1
- Plastic coated shelf GN1/1
- Stainless steel shelf EN60x40
- Plastic coated shelf EN60x40
- Pair of type L slides 398 mm GN-EN
- Sterilizing UV lamp (U version)

COSMO - wi-fi control

Cosmo is the wi-fi technology that allows MODI blast chillers to be connected, updated and monitored from smartphones. MODI is also a Cosmo hub and allows remote supervision of the Coldline appliances connected to it. From the CosmoApp you can check the operating conditions of each machine and receive alerts in the event of abnormal operation.

Technical draw

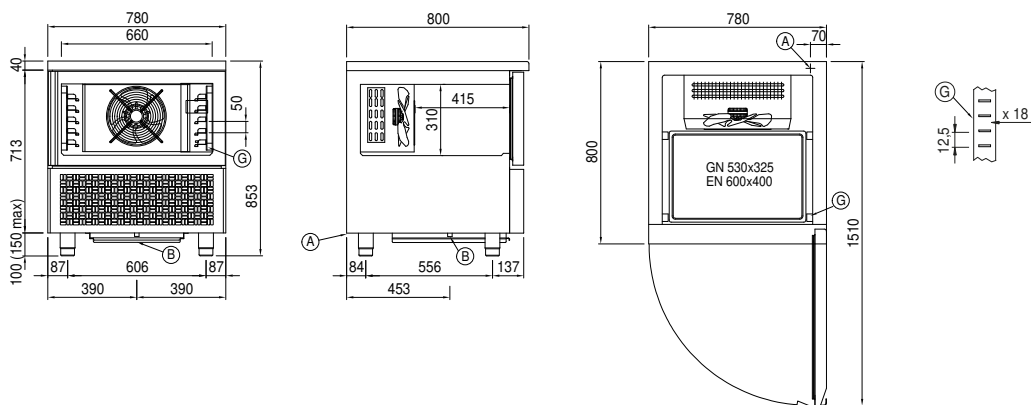

A: Power supply cable outlet

B: Condensation water drain

G: Racks pitch

In order to constantly offer the best possible products we reserve the right to make changes on technical specifications without incurring any obligation for equipment previously or subsequently sold.